

2025-1

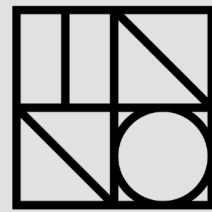

I N N O

L I S T A D E P R E C I O S

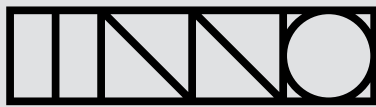

Todos los calados/celosías se fabrican en doble cara.
 Las tolerancias dimensionales son de más/menos 3 mm en todas sus aristas.
 La Tonalidad de los productos varia por la naturaleza del concreto.
 Descarga el catalogo completo en www.inno.com.co

PRECIOS
 CALADOS/CELOSIAS

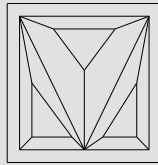

BANDASSI
 29 cm x 29 cm x 9.5 cm

RENDIMIENTO **11,1 und/m2** PESO **11,0 kg/und** PRECIO **34,700/Und** **385,170 /m²**

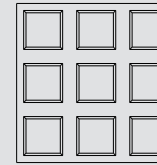

KIPSSE
 34 cm x 34 cm x 8 cm

RENDIMIENTO **8,2und/m2** PESO **10,0 kg/und** PRECIO **47,000/Und** **385,400 /m²**

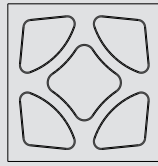

APINNA
 29 cm x 29 cm x 8 cm

RENDIMIENTO **11,1 und/m2** PESO **8,0 kg/und** PRECIO **34,700/Und** **385,170 /m²**

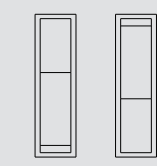

MASSARI
 49 cm x 14 cm x 10 cm

RENDIMIENTO **13,4 und/m2** PESO **9,0 kg/und** PRECIO **28,700/Und** **384,580 /m²**

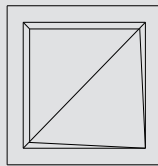

ALVEERA
 29 cm x 29 cm x 9 cm

RENDIMIENTO **11,1 und/m2** PESO **9,0 kg/und** PRECIO **34,700/Und** **385,170 /m²**

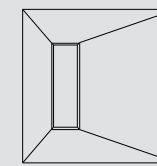

AMASSU
 32 cm x 32 cm x 8,5 cm

RENDIMIENTO **9,2 und/m2** PESO **18,0 kg/und** PRECIO **45,000/Und** **414,000 /m²**

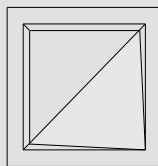

ALVEERA+PINTURA
 29 cm x 29 cm x 9 cm

RENDIMIENTO **11,1 und/m2** PESO **9,0 kg/und** PRECIO **45,000/Und** **499.500 /m²**

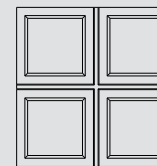

CELDDY
 29 cm x 29 cm x 9 cm

RENDIMIENTO **11,1 und/m2** PESO **8,0 kg/und** PRECIO **34,700/Und** **385,170 /m²**

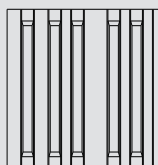

SARINNO
 34 cm x 34 cm x 10 cm

RENDIMIENTO **8.2 und/m2** PESO **14,0 kg/und** PRECIO **49,800/Und** **408,360 /m²**

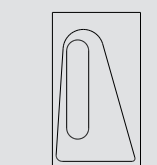

CINTTO
 35 cm x 20 cm x 9 cm

RENDIMIENTO **13,2 und/m2** PESO **8,5 kg/und** PRECIO **29,200/Und** **385,440 /m²**

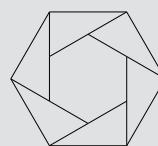

POLINNO
 D24,5 cm x 13,5 cm

RENDIMIENTO **18,2 und/m2** PESO **7,5 kg/und** PRECIO **23,000/Und** **418,600 /m²**

COLORES DISPONIBLES

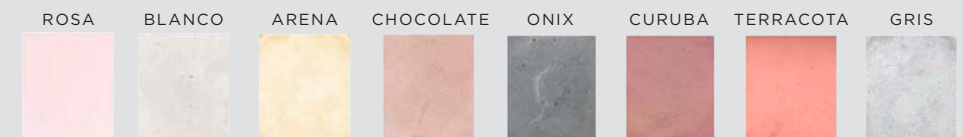

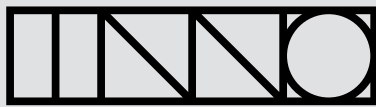

Todos los calados/celosías se fabrican en doble cara.
 Las tolerancias dimensionales son de más/menos 3 mm en todas sus aristas.
 La Tonalidad de los productos varia por la naturaleza del concreto.
 Descarga el catalogo completo en www.inno.com.co

PRECIOS
 CALADOS/CELOSIAS

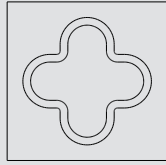

FLOREEA
 29 cm x 29 cm x 9 cm

RENDIMIENTO **11,1 und/m2** PESO **10,0 kg/und** PRECIO **34,700/Und** **385,170 /m²**

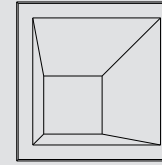

REINN A y C
 22 cm x 22 cm x 10 cm

RENDIMIENTO **19 und/m2** PESO **8,0 kg/und** PRECIO **20,200/Und** **383,800 /m²**

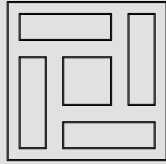

NIKKOVY
 29 cm x 29 cm x 9 cm

RENDIMIENTO **11,1 und/m2** PESO **9,0kg/und** PRECIO **34,700/Und** **385,170 /m²**

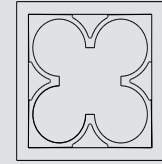

APISS
 24 cm x 24 cm x 9 cm

RENDIMIENTO **16 und/m2** PESO **5,5 kg/und** PRECIO **24,000/Und** **384,000 /m²**



TIFFOR A
 40 cm x 11,5 cm x 10 cm

RENDIMIENTO **19,5 und/m2** PESO **7,5 kg/und** PRECIO **19,800/Und** **386,100 /m²**

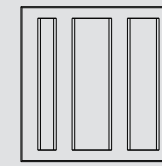

BITTAK A
 29 cm x 29 cm x 9 cm

RENDIMIENTO **11,1 und/m2** PESO **11,0 kg/und** PRECIO **34,600/Und** **384,060 /m²**

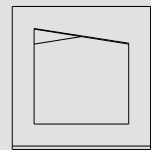

SERYCATTO
 21 cm x 21 cm x 11 cm

RENDIMIENTO **25,0 und/m2** PESO **8,0 kg/und** PRECIO **15,400/Und** **385,000 /m²**

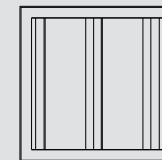

BITTAK B
 29 cm x 29 cm x 9 cm

RENDIMIENTO **11,1 und/m2** PESO **11,0 kg/und** PRECIO **34,600/Und** **384,060 /m²**

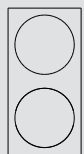

SCUTTEL
 40 cm x 20 cm x 8 cm

RENDIMIENTO **11,6 und/m2** PESO **19,5 kg/und** PRECIO **33,100/Und** **383,960 /m²**

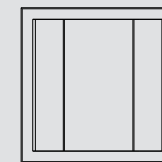

BITTAK C
 29 cm x 29 cm x 9 cm

RENDIMIENTO **11,1 und/m2** PESO **11,0 kg/und** PRECIO **34,600/Und** **384,060 /m²**



TIFFOR D
 40 cm x 11,5 cm x 10 cm

RENDIMIENTO **19,5 und/m2** PESO **7,5 kg/und** PRECIO **19,800/Und** **386,100 /m²**

COLORES DISPONIBLES

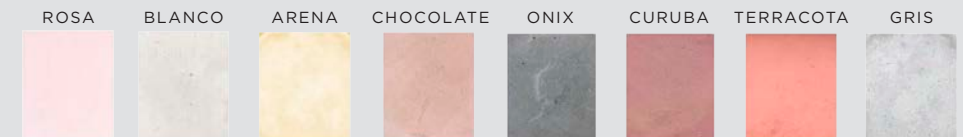

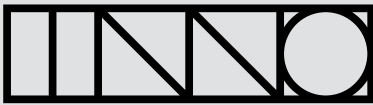

Todos los calados/cecosías se fabrican en doble cara.
 Las tolerancias dimensionales son de más/menos 3 mm en todas sus aristas.
 La Tonalidad de los productos varia por la naturaleza del concreto.
 Descarga el catalogo completo en www.inno.com.co

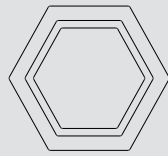

DORSSATA
 23 cm x 27 cm x 8,5 cm

RENDIMIENTO	PESO	PRECIO	
18,2 und/m2	7,5 kg/und	21,100/Und	384,020 /m²



MARKKY
 29 cm x 14 cm x 8 cm

RENDIMIENTO	PESO	PRECIO	
22,2 und/m2	5,0 kg/und	17,300/Und	384,060 /m²

ELEMENTO ADICIONAL

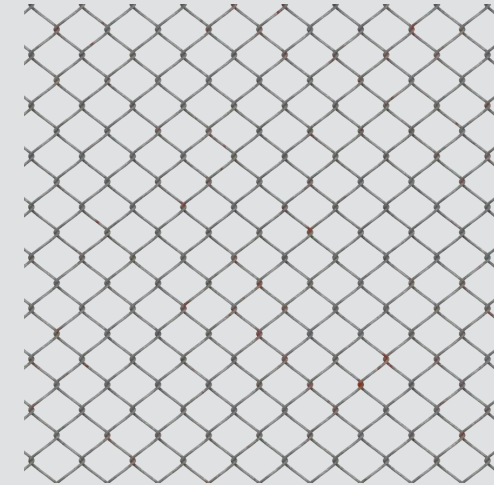

DESCRIPCIÓN
MALLA (CALIBRES VARIABLES)

EL VALOR DEL ELEMENTO SE AUMENTA UN 25% POR M²



DESCRIPCIÓN
VIDRIO CON VARIANTES (COLOR, CRUDO, TEMPLADO, ETC)

EL VALOR DEL ELEMENTO SE AUMENTA UN 25% POR M²

COLORES DISPONIBLES

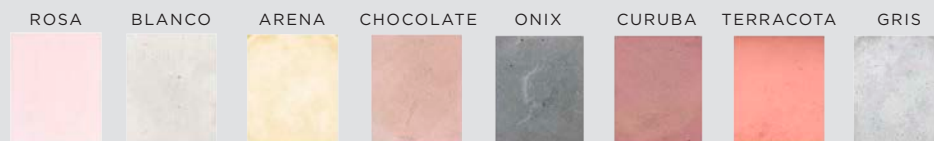

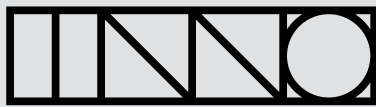

Las tolerancias dimensionales son desde más/menos 3 mm en todas sus aristas.
 La Tonalidad de los productos varia por la naturaleza del concreto.
 Descarga el catalogo completo en www.inno.com.co
 Precios antes del IVA.

PRECIOS
ENCHAPES

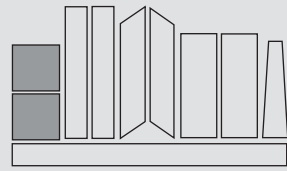

LINNEO 10
10 cm x 10 cm x 1.5 cm

RENDIMIENTO **100 und/m2** PESO **0,4 kg/und** PRECIO **1,400/Und** **140,000 /m²**

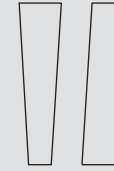

LIESS
6 cm x 20 cm x 1.8 cm

RENDIMIENTO **83,3 und/m2** PESO **0,3 kg/und** PRECIO **1,700/Und** **141,100 /m²**

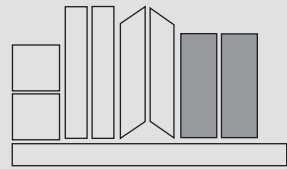

LINNEO 23
23 cm x 7,8 cm x 1.5 cm

RENDIMIENTO **54,0 und/m2** PESO **0,4 kg/und** PRECIO **2,600/Und** **140,400 /m²**

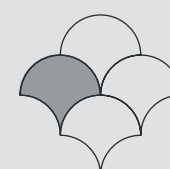

ABBY
D: 15 cm x 1,5

RENDIMIENTO **83 und/m2** PESO **0,3 kg/und** PRECIO **1,700/Und** **141,100 /m²**

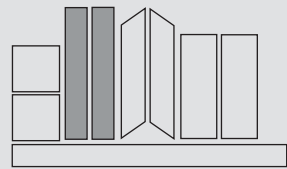

LINNEO 30
30 cm x 5 cm x 1.5 cm

RENDIMIENTO **66,7 und/m2** PESO **0,6 kg/und** PRECIO **2,100/Und** **140,070 /m²**



ALICC
35,4 cm x 5 cm x 3,5 cm

RENDIMIENTO **56,5 und/m2** PESO **0,5 kg/und** PRECIO **2,550/Und** **141,525 /m²**

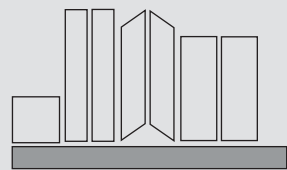

LINNEO 60
60 cm x 5 cm x 1.8 cm

RENDIMIENTO **33,3 und/m2** PESO **1,4 kg/und** PRECIO **4,200/Und** **139,860 /m²**
+IVA

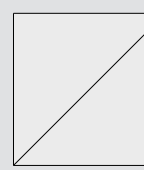

LUENSSI
20 cm x 20 cm x 2.0 cm

RENDIMIENTO **25 und/m2** PESO **2,5 kg/und** PRECIO **5,600/Und** **140,000 /m²**

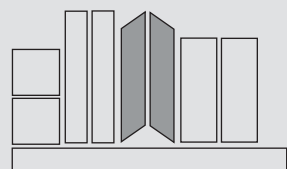

IBERISS
26 cm x 6 cm x 1,5 cm

RENDIMIENTO **85,0 und/m2** PESO **0,4 kg/und** PRECIO **1,700/Und** **144,500 /m²**



LIFFERO
15 cm x 25 cm x 1.5 cm

RENDIMIENTO **26,7und/m2** PESO **3,0 kg/und** PRECIO **12,650/Und** **140,415 /m²**

LINNEO 120
120 cm x 7 cm x 5 cm



RENDIMIENTO **14,0 und/m2** PESO **3,9 kg/und** PRECIO **10,000/Und** **140,000 /m²**
+IVA

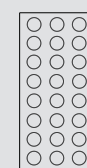

KOLMOSS
26,6 cm x 12,7 cm x 1.5 cm

RENDIMIENTO **30,0 und/m2** PESO **0,5 kg/und** PRECIO **4,670/Und** **140,100 /m²**

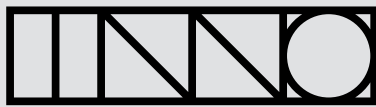

Las tolerancias dimensionales son desde más/menos 3 mm en todas sus aristas.
La Tonalidad de los productos varia por la naturaleza del concreto.
Descarga el catalogo completo en www.inno.com.co
Precios antes del IVA.

PRECIOS
ENCHAPES

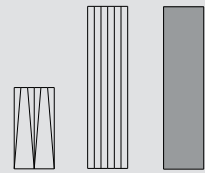

STENNO A

60 cm x 15 cm x 2 cm

RENDIMIENTO	PESO	PRECIO	
11,1 und/m2	4,0 kg/und	12,650/Und	140,415 /m²

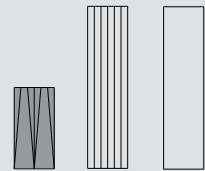

STENNO B

30 cm x 15 cm x 2 cm

RENDIMIENTO	PESO	PRECIO	
22,2 und/m2	2,5 kg/und	6,300/Und	139,860 /m²

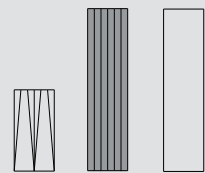

STENNO C

60 cm x 15 cm x 2 cm

RENDIMIENTO	PESO	PRECIO	
11,1 und/m2	4,0 kg/und	12,650/Und	140,415 /m²

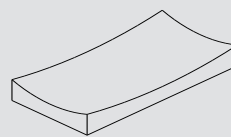

MEEAI

5 cm x 10 cm x 1,5 cm

RENDIMIENTO	PESO	PRECIO	
200 und/m2	0,2 kg/und	700/Und	140,000 /m²

COLORES DISPONIBLES

ROSA BLANCO ARENA CHOCOLATE ONIX CURUBA TERRACOTA GRIS

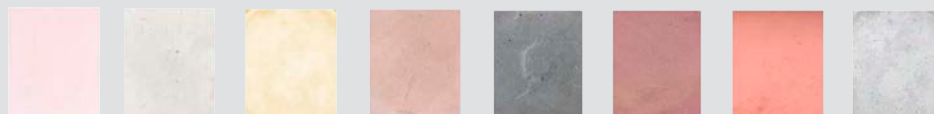

Los valores para los enchapes están antes de agregarles IVA.
Las tolerancias dimensionales son desde 3 mm en todas sus aristas.
La Tonalidad de los productos varia por la naturaleza del concreto.

ACABADO ADICIONAL

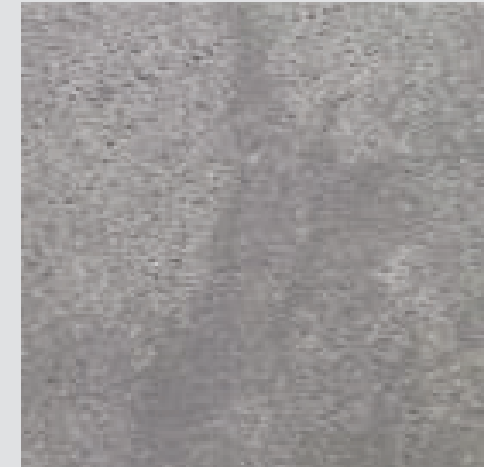

DESCRIPCIÓN
MICRODECAPADO

EL VALOR DEL ELEMENTO SE AUMENTA UN 25% POR M²



DESCRIPCIÓN
PULIDO

EL VALOR DEL ELEMENTO SE AUMENTA UN 25% POR M²

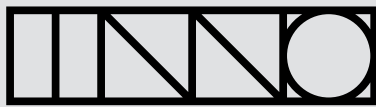

Las tolerancias dimensionales son desde más/menos 3 mm en todas sus aristas.
La Tonalidad de los productos varia por la naturaleza del concreto.
Descarga el catalogo completo en www.inno.com.co
Precios antes del IVA.

PRECIOS

PISOS

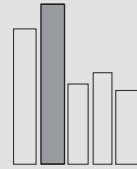

LISSY 120
120 cm x 20 cm x 5 cm

RENDIMIENTO	PESO	PRECIO	
4,2 und/m2	18,0 kg/und	55,500/Und	233,310 /m² +IVA

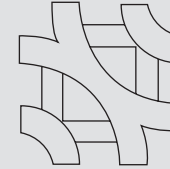

GRAMOQUIN SYRIACCO
30 cm x 30 cm x 6 cm

RENDIMIENTO	PESO	PRECIO	
11,1 und/m2	3,5 kg/und	16,500/Und	183,150/m²

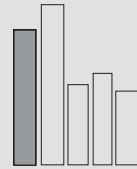

LISSY 100
100 cm x 15 cm x 5 cm

RENDIMIENTO	PESO	PRECIO	
6,7 und/m2	15,0 kg/und	33,110/Und	221,837 /m² +IVA



GRAMOQUIN ANDREENA
40 cm x 20 cm x 5 cm

RENDIMIENTO	PESO	PRECIO	
8,4 und/m2	7,0 kg/und	21,560/Und	222,068 /m²

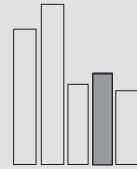

LISSY 75
75 cm x 13,5 cm x 4 cm

RENDIMIENTO	PESO	PRECIO	
9,9 und/m2	9,5 kg/und	23,100/Und	228,690 /m² +IVA

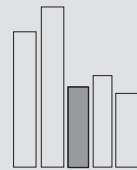

LISSY 60
60 cm x 10 cm x 1.5 cm

RENDIMIENTO	PESO	PRECIO	
100 und/m2	0,3 kg/und	20,130/Und	223,443 /m² +IVA

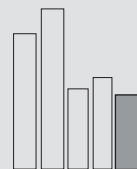

LISSY 50
50 cm x 20 cm x 5 cm

RENDIMIENTO	PESO	PRECIO	
10 und/m2	10,0 kg/und	22,500/Und	225,500 /m² +IVA

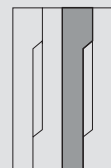

GRAMOQUIN LAGGEL
80 cm x 15 cm x 5 cm

RENDIMIENTO	PESO	PRECIO	
8,4 und/m2	11,1 kg/und	26,400/Und	221,760 /m² +IVA

COLORES DISPONIBLES

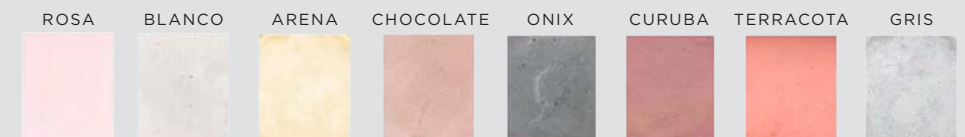

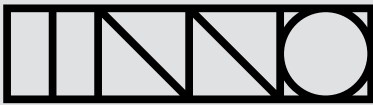

Los valores para los pisos están antes de agregarles IVA.
Las tolerancias dimensionales son desde 3 mm en todas sus aristas.
La Tonalidad de los productos varia por la naturaleza del concreto.
Precios 2025 descarga el catalogo completo en www.inno.com.co

PRECIOS

PISOS

COXXO



RENDIMIENTO

Las piezas se ubican con una separación de 1 a 3 cm entre ellas con los siguientes consumos sugeridos. (Para modulación recomendada consultar ficha técnica).

PIEZA A: 4 UND
PIEZA B: 6 UND
PIEZA C: 6 UND
PIEZA D: 2 UND

Para un total aproximado de 18 Und/m²

PESO	PRECIO
92,0 Kg/m²	180,000 /m²

COLORES DISPONIBLES

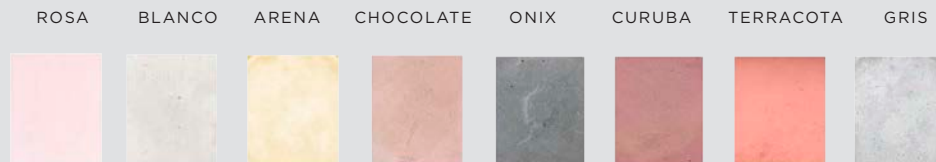

ACABADO ADICIONAL



DESCRIPCIÓN
MICRODECAPADO

EL VALOR DEL ELEMENTO SE AUMENTA UN 25% POR M²

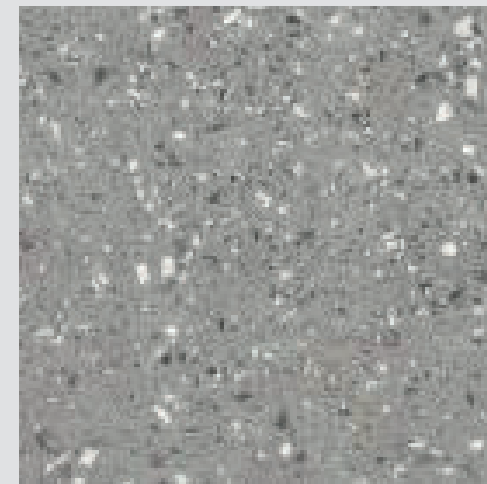

DESCRIPCIÓN
PULIDO

EL VALOR DEL ELEMENTO SE AUMENTA UN 25% POR M²

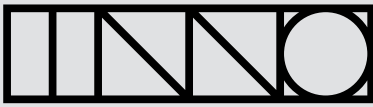

Los valores para los mobiliarios están antes de agregarles IVA.
Las tolerancias dimensionales son desde 3 mm en todas sus aristas.
La Tonalidad de los productos varia por la naturaleza del concreto.
Precios 2025 descarga el catalogo completo en www.inno.com.co

PRECIOS
MOBILIARIO

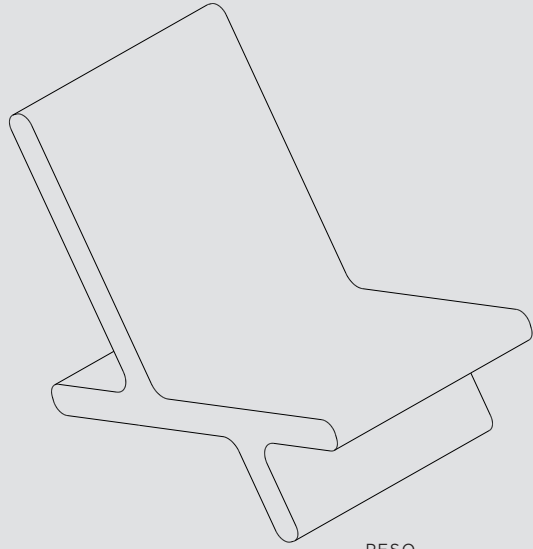

ONANZZA
70 cm x 55 cm x 92 cm

PESO
110 kg/und

PRECIO
1'472,000/Und
+IVA

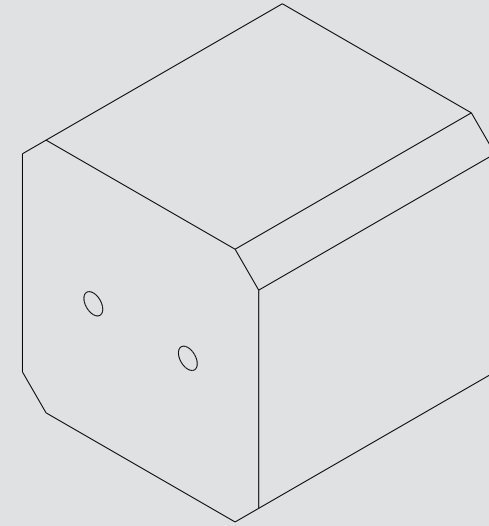

PONNA
50 cm x 50 cm x 50 cm

PESO
100 kg/und

PRECIO
483,000/Und

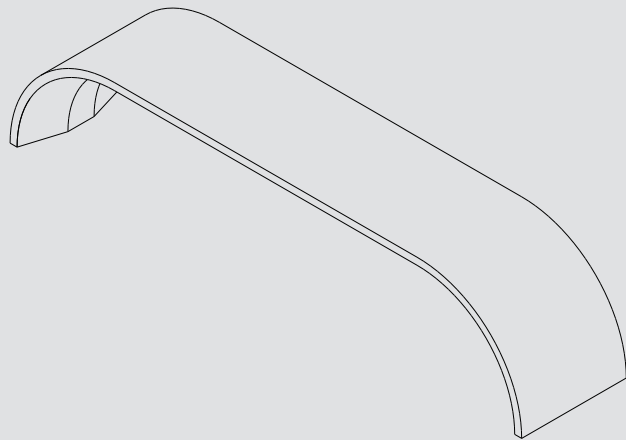

ASTTER
220 cm x 45 cm x 45 cm

PESO
180 kg/und

PRECIO
1'472,000/Und
+IVA

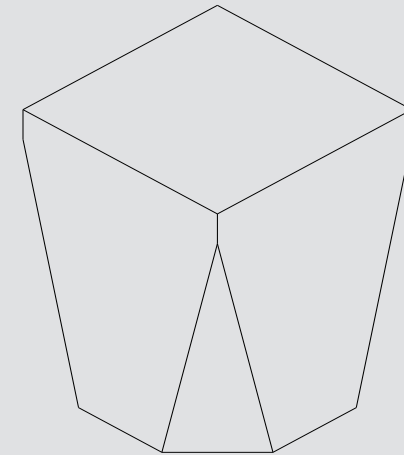

LIVVY
35 cm x 35 cm x 45 cm

PESO
50 kg/und

PRECIO
483,000/Und

COLORES DISPONIBLES

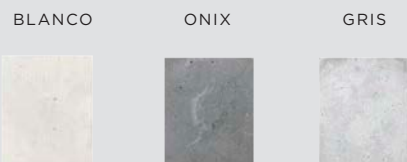

COLORES DISPONIBLES

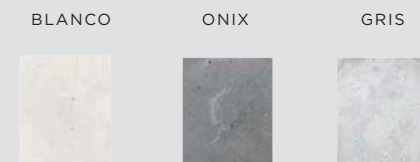

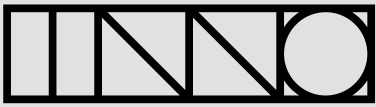

Los valores para los mobiliarios están antes de agregarles IVA.
Las tolerancias dimensionales son desde 3 mm en todas sus aristas.
La Tonalidad de los productos varia por la naturaleza del concreto.
Precios 2025 descarga el catalogo completo en www.inno.com.co

PRECIOS
MOBILIARIO

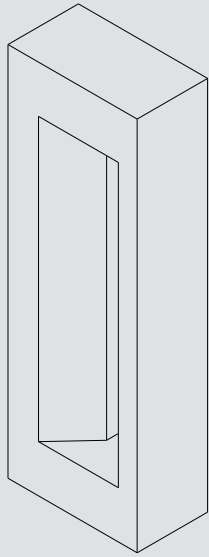

TRALISS
80 cm x 15 cm x 25 cm

PESO
50 kg/und

PRECIO
632,500/Und
+IVA

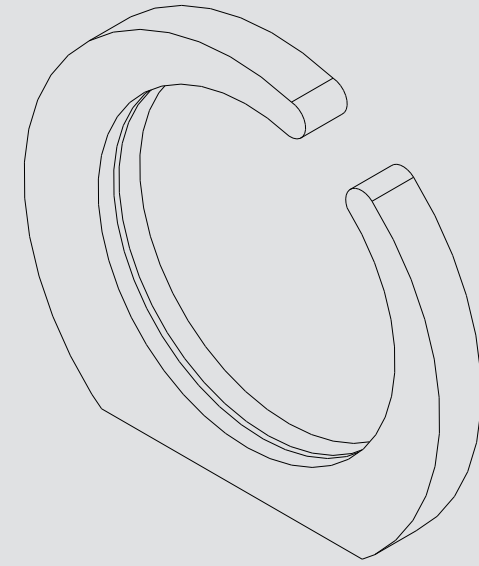

TERRESTRISS
78 cm x 69 cm x 8.5 cm

PESO
38 kg/und

PRECIO
650,000/Und
+IVA

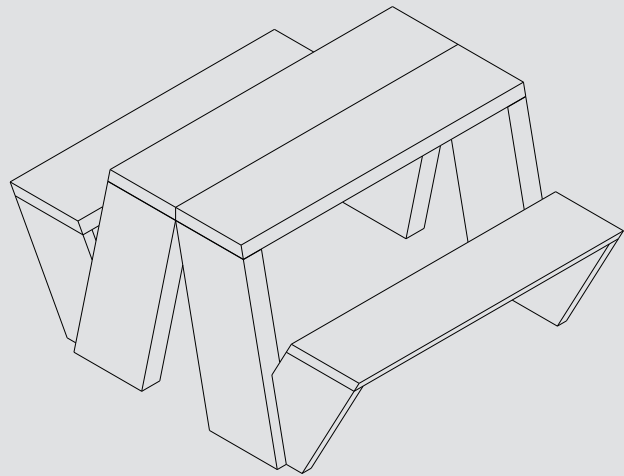

ELEGANZZ
120 cm x 60 cm x 75-45 cm

PESO
320 kg/und

PRECIO
2'070,000/Und
+IVA

COLORES DISPONIBLES

BLANCO

ONIX

GRIS



COLORES DISPONIBLES

BLANCO

ONIX

GRIS

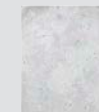

NOSOTROS

COLOMBIA

Medellin, Antioquia
Colombia

+57 321 800 9632
contacto@innovacron.co

CARIBE Y CENTRO AMERICA

Rep. Dominicana
Costa Rica

+1 312 887 6845
Internacional@innovacro.co

SOCIAL

@Innovacron
Pinterest.com/Innovacron
www.inno.com.co



INNO