

2026-1

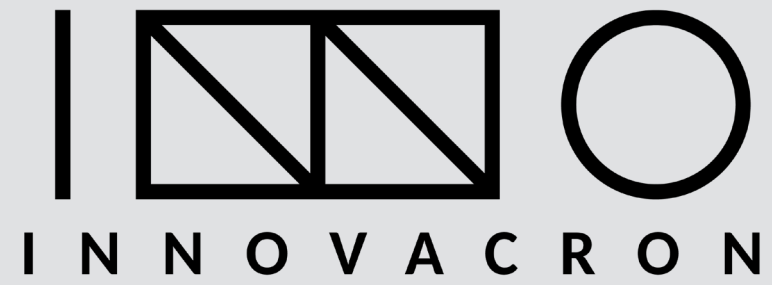

L I S T A D E P R E C I O S



Todos los calados/celosías se fabrican en doble cara.
 Las tolerancias dimensionales son de más/menos 3 mm en todas sus aristas.
 La Tonalidad de los productos varia por la naturaleza del concreto.
 Descarga el catálogo completo en www.innovacron.com.co

PRECIOS
 CALADOS/CELOSIAS

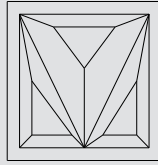

BANDASSI
 29 cm x 29 cm x 9.5 cm

RENDIMIENTO	PESO	PRECIO	
11,1 und/m2	11,0 kg/und	41,640/Und	462,204 /m²

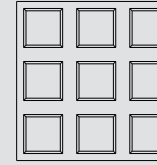

KIPSSE
 34 cm x 34 cm x 8 cm

RENDIMIENTO	PESO	PRECIO	
8,2und/m2	10,0 kg/und	56,400/Und	462,480 /m²

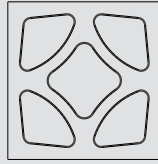

APINNA
 29 cm x 29 cm x 8 cm

RENDIMIENTO	PESO	PRECIO	
11,1 und/m2	8,0 kg/und	41,640/Und	462,204 /m²

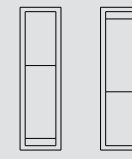

MASSARI
 49 cm x 14 cm x 10 cm

RENDIMIENTO	PESO	PRECIO	
13,4 und/m2	9,0 kg/und	34,440/Und	461,496 /m²

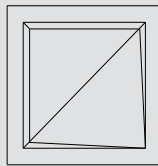

ALVEERA
 29 cm x 29 cm x 9 cm

RENDIMIENTO	PESO	PRECIO	
11,1 und/m2	9,0 kg/und	41,640/Und	462,204 /m²

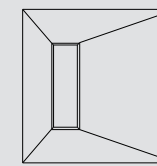

AMASSU
 32 cm x 32 cm x 8,5 cm

RENDIMIENTO	PESO	PRECIO	
9,2 und/m2	18,0 kg/und	54,000/Und	496,800 /m²

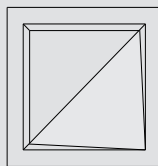

ALVEERA+PINTURA
 29 cm x 29 cm x 9 cm

RENDIMIENTO	PESO	PRECIO	
11,1 und/m2	9,0 kg/und	54,000/Und	599,400 /m²

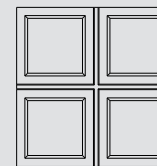

CELDDY
 29 cm x 29 cm x 9 cm

RENDIMIENTO	PESO	PRECIO	
11,1 und/m2	8,0 kg/und	41,640/Und	462,204 /m²

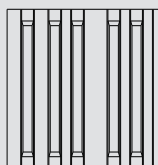

SARINNO
 34 cm x 34 cm x 9,5 cm

RENDIMIENTO	PESO	PRECIO	
8.2 und/m2	14,0 kg/und	59,760/Und	490,032 /m²

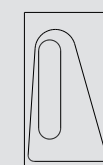

CINTTO
 35 cm x 20 cm x 9 cm

RENDIMIENTO	PESO	PRECIO	
13,2 und/m2	8,5 kg/und	35,040/Und	462,528 /m²

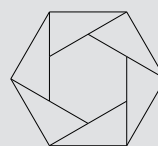

POLINNO
 D24,5 cm x 13,5 cm

RENDIMIENTO	PESO	PRECIO	
18,2 und/m2	7,5 kg/und	27,370/Und	498,134 /m²

COLORES DISPONIBLES





Todos los calados/celosías se fabrican en doble cara.
 Las tolerancias dimensionales son de más/menos 3 mm en todas sus aristas.
 La Tonalidad de los productos varia por la naturaleza del concreto.
 Descarga el catálogo completo en www.innovacron.com.co

PRECIOS
 CALADOS/CELOSIAS

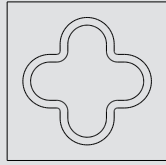

FLOREEA
 29 cm x 29 cm x 9 cm

RENDIMIENTO **11,1 und/m2** PESO **10,0 kg/und** PRECIO **41,640/Und** **462,204 /m²**

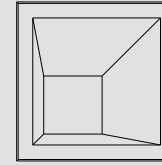

REINN A y C
 22 cm x 22 cm x 10 cm

RENDIMIENTO **19 und/m2** PESO **8,0 kg/und** PRECIO **24,240/Und** **460,560 /m²**

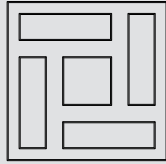

NIKKOVY
 29 cm x 29 cm x 9 cm

RENDIMIENTO **11,1 und/m2** PESO **9,0kg/und** PRECIO **41,640/Und** **462,204 /m²**

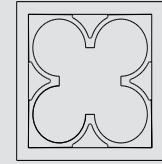

APISS
 24 cm x 24 cm x 9 cm

RENDIMIENTO **16 und/m2** PESO **5,5 kg/und** PRECIO **28,800/Und** **460,800 /m²**



TIFFOR A
 40 cm x 11,5 cm x 10 cm

RENDIMIENTO **19,5 und/m2** PESO **7,5 kg/und** PRECIO **23,760/Und** **463,320 /m²**

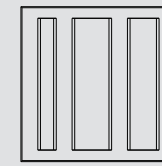

BITTAK A
 29 cm x 29 cm x 9 cm

RENDIMIENTO **11,1 und/m2** PESO **11,0 kg/und** PRECIO **41,520/Und** **460,872/m²**



MARKKY
 29 cm x 14 cm x 8 cm

RENDIMIENTO **22,2 und/m2** PESO **5,0 kg/und** PRECIO **20,760/Und** **460,872 /m²**

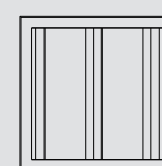

BITTAK B
 29 cm x 29 cm x 9 cm

RENDIMIENTO **11,1 und/m2** PESO **11,0 kg/und** PRECIO **41,520/Und** **460,872/m²**

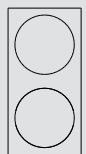

ANDREENA
 40 cm x 20 cm x 8 cm

RENDIMIENTO **11,6 und/m2** PESO **19,5 kg/und** PRECIO **39,720/Und** **460,752 /m²**

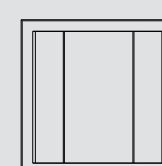

BITTAK C
 29 cm x 29 cm x 9 cm

RENDIMIENTO **11,1 und/m2** PESO **11,0 kg/und** PRECIO **41,520/Und** **460,872/m²**



TIFFOR D
 40 cm x 11,5 cm x 10 cm

RENDIMIENTO **19,5 und/m2** PESO **7,5 kg/und** PRECIO **23,760/Und** **463,320 /m²**

COLORES DISPONIBLES





Todos los calados/celosías se fabrican en doble cara.
 Las tolerancias dimensionales son de más/menos 3 mm en todas sus aristas.
 La Tonalidad de los productos varia por la naturaleza del concreto.
 Descarga el catalogo completo en www.innovacron.com.co

PRECIOS

CALADOS/CELOSIAS

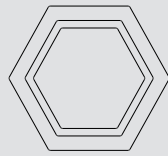

DORSSATA
 23 cm x 27 cm x 8,5 cm

RENDIMIENTO	PESO	PRECIO	
18,2 und/m2	7,5 kg/und	25,320/Und	460,824 /m²

ELEMENTO ADICIONAL

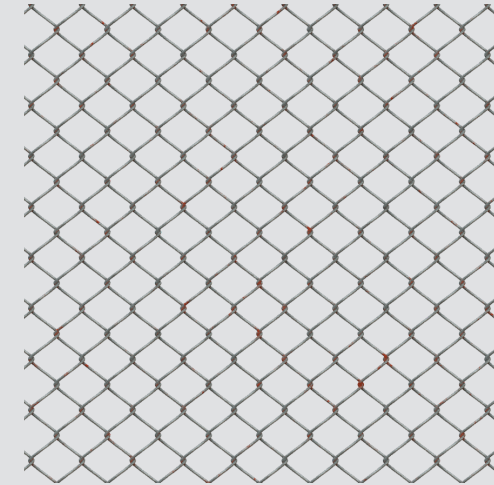

DESCRIPCIÓN
MALLA (CALIBRES VARIABLES)

EL VALOR DEL ELEMENTO SE AUMENTA UN 25% POR M²



DESCRIPCIÓN
VIDRIO CON VARIANTES (COLOR, CRUDO, TEMPLADO, ETC)

EL VALOR DEL ELEMENTO SE AUMENTA UN 25% POR M²

COLORES DISPONIBLES





Las tolerancias dimensionales son desde más/menos 3 mm en todas sus aristas.
 La Tonalidad de los productos varia por la naturaleza del concreto.
 Descarga el catálogo completo en www.innovacron.com.co
 Precios antes del IVA.

PRECIOS
ENCHAPES

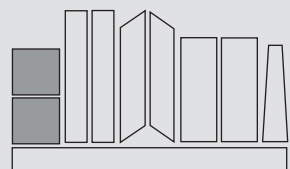

LINNEO 10
10 cm x 10 cm x 1.5 cm

RENDIMIENTO	PESO	PRECIO	
100 und/m2	0,4 kg/und	1,722/Und	172,200/m² +IVA

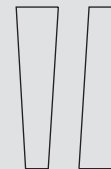

LIESS
6 cm x 20 cm x 1.8 cm

RENDIMIENTO	PESO	PRECIO	
83,3 und/m2	0,3 kg/und	2,091/Und	173,553 /m² +IVA

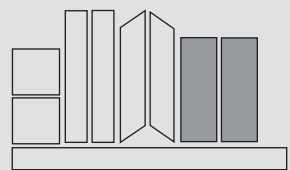

LINNEO 23
23 cm x 7,8 cm x 1.5 cm

RENDIMIENTO	PESO	PRECIO	
54,0 und/m2	0,4 kg/und	3,198/Und	172,692 /m² +IVA

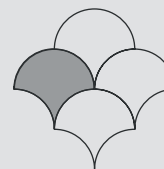

ABBY
D: 15 cm x 1,5

RENDIMIENTO	PESO	PRECIO	
83 und/m2	0,3 kg/und	2,091/Und	173,553 /m² +IVA

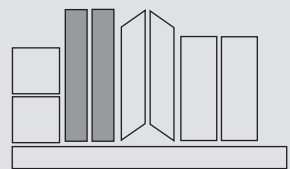

LINNEO 30
30 cm x 5 cm x 1.5 cm

RENDIMIENTO	PESO	PRECIO	
66,7 und/m2	0,6 kg/und	2,583/Und	172,286 /m² +IVA

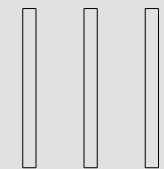

ALICC
35,4 cm x 5 cm x 3,5 cm

RENDIMIENTO	PESO	PRECIO	
56,5 und/m2	0,5 kg/und	3,137/Und	174,076 /m² +IVA

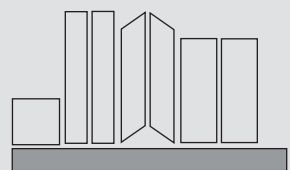

LINNEO 60
60 cm x 5 cm x 1.8 cm

RENDIMIENTO	PESO	PRECIO	
33,3 und/m2	1,4 kg/und	5,166/Und	172,028 /m² +IVA

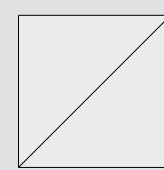

LUENSSI
20 cm x 20 cm x 2.0 cm

RENDIMIENTO	PESO	PRECIO	
25 und/m2	2,5 kg/und	6,888/Und	172,200 /m² +IVA

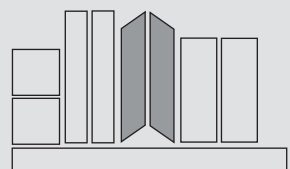

IBERISS
26 cm x 6 cm x 1,5 cm

RENDIMIENTO	PESO	PRECIO	
85,0 und/m2	0,4 kg/und	2,091/Und	177,735 /m² +IVA

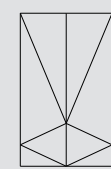

LIFFERO
15 cm x 25 cm x 1.5 cm

RENDIMIENTO	PESO	PRECIO	
26,7und/m2	3,0 kg/und	15,560/Und	172,710 /m² +IVA

LINNEO 120
120 cm x 7 cm x 5 cm

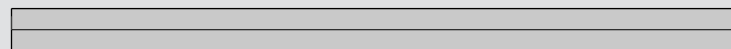

RENDIMIENTO	PESO	PRECIO	
14,0 und/m2	3,9 kg/und	12,300/Und	172,200 /m² +IVA

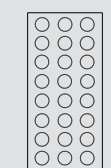

KOLMOSS
26,6 cm x 12,7 cm x 1.5 cm

RENDIMIENTO	PESO	PRECIO	
30,0 und/m2	0,5 kg/und	---,--- /Und	---,--- /m² +IVA



Las tolerancias dimensionales son desde más/menos 3 mm en todas sus aristas.
 La Tonalidad de los productos varia por la naturaleza del concreto.
 Descarga el catálogo completo en www.innovacron.com.co
 Precios antes del IVA.

PRECIOS
 ENCHAPES

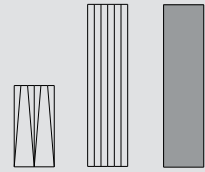

STENNO A
 60 cm x 15 cm x 2 cm

RENDIMIENTO	PESO	PRECIO	
11,1 und/m2	4,0 kg/und	15,560/Und	172,710 /m² +IVA

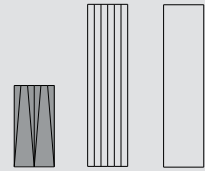

STENNO B
 30 cm x 15 cm x 2 cm

RENDIMIENTO	PESO	PRECIO	
22,2 und/m2	2,5 kg/und	7,749/Und	172,710 /m² +IVA

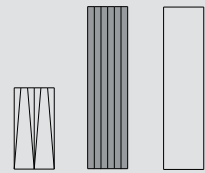

STENNO C
 60 cm x 15 cm x 2 cm

RENDIMIENTO	PESO	PRECIO	
11,1 und/m2	4,0 kg/und	15,560/Und	172,710 /m² +IVA

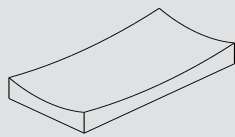

BUCKK
 10 cm x 20 cm x 2,5 cm

RENDIMIENTO	PESO	PRECIO	
50 und/m2	0,45 kg/und	---,---/Und	---,--- /m² +IVA

COLORES DISPONIBLES

ROSA BLANCO ARENA CHOCOLATE ONIX CURUBA TERRACOTA GRIS



Los valores para los enchapes están antes de agregarles IVA.
 Las tolerancias dimensionales son desde 3 mm en todas sus aristas.
 La Tonalidad de los productos varia por la naturaleza del concreto.

ACABADO ADICIONAL



DESCRIPCIÓN
MICRODECAPADO

EL VALOR DEL ELEMENTO SE AUMENTA UN 25% POR M²



DESCRIPCIÓN
PULIDO

EL VALOR DEL ELEMENTO SE AUMENTA UN 25% POR M²



Las tolerancias dimensionales son desde más/menos 4 mm en todas sus aristas.
 La Tonalidad de los productos varia por la naturaleza del concreto.
 Descarga el catálogo completo en www.innovacron.com.co
 Precios antes del IVA.

PRECIOS

PISOS

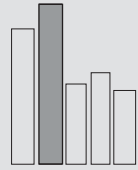

LISSY 120
 120 cm x 20 cm x 5 cm

RENDIMIENTO	PESO	PRECIO	
4,2 und/m2	18,0 kg/und	68,265/Und	286,713 /m² +IVA

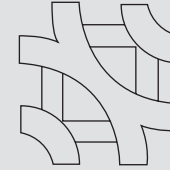

GRAMOQUIN SYRIACCO
 30 cm x 30 cm x 6 cm

RENDIMIENTO	PESO	PRECIO	
11,1 und/m2	8,5 kg/und	19,800/Und	219,780/m²

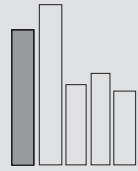

LISSY 100
 100 cm x 15 cm x 5 cm

RENDIMIENTO	PESO	PRECIO	
6,7 und/m2	15,0 kg/und	40,725/Und	272,860 /m² +IVA



GRAMOQUIN MONTICO
 40 cm x 20 cm x 5 cm

RENDIMIENTO	PESO	PRECIO	
8,4 und/m2	7,0 kg/und	25,872/Und	266,482 /m²

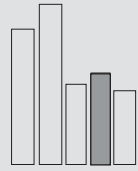

LISSY 75
 75 cm x 13,5 cm x 4 cm

RENDIMIENTO	PESO	PRECIO	
9,9 und/m2	9,5 kg/und	28,413/Und	281,289 /m² +IVA

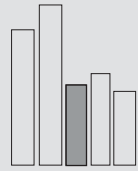

LISSY 60
 60 cm x 10 cm x 5 cm

RENDIMIENTO	PESO	PRECIO	
100 und/m2	0,3 kg/und	24,760/Und	274,835 /m² +IVA

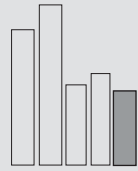

LISSY 50
 50 cm x 20 cm x 4 cm

RENDIMIENTO	PESO	PRECIO	
10 und/m2	10,0 kg/und	27,675/Und	276,750 /m² +IVA

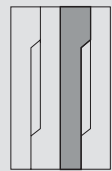

GRAMOQUIN LAGGEL
 80 cm x 15 cm x 5 cm

RENDIMIENTO	PESO	PRECIO	
8,4 und/m2	11,1 kg/und	31,680/Und	266,112 /m² +IVA

COLORES DISPONIBLES





Los valores para los pisos están antes de agregarles IVA.
 Las tolerancias dimensionales son desde 3 mm en todas sus aristas.
 La Tonalidad de los productos varia por la naturaleza del concreto.
 Precios 2026 descarga el catalogo completo en www.innovacron.com.co

PRECIOS

PISOS

COXXO



RENDIMIENTO

Las piezas se ubican con una separación de 1 a 3 cm entre ellas con los siguientes consumos sugeridos. (Para modulación recomendada consultar ficha técnica).

PIEZA A: 4 UND
 PIEZA B: 6 UND
 PIEZA C: 6 UND
 PIEZA D: 2 UND

Para un total aproximado de 18 Und/m²

PESO PRECIO
 ---,--- Kg/m² ---,--- /m²

COLORES DISPONIBLES

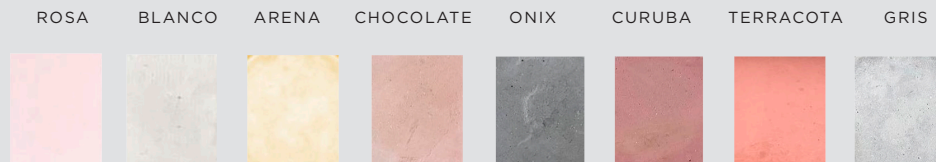

ACABADO ADICIONAL



DESCRIPCIÓN
MICRODECAPADO

EL VALOR DEL ELEMENTO SE AUMENTA UN 25% POR M²



DESCRIPCIÓN
PULIDO

EL VALOR DEL ELEMENTO SE AUMENTA UN 25% POR M²



Los valores para los mobiliarios están antes de agregarles IVA.
 Las tolerancias dimensionales son desde 3 mm en todas sus aristas.
 La Tonalidad de los productos varia por la naturaleza del concreto.

PRECIOS
MOBILIARIO

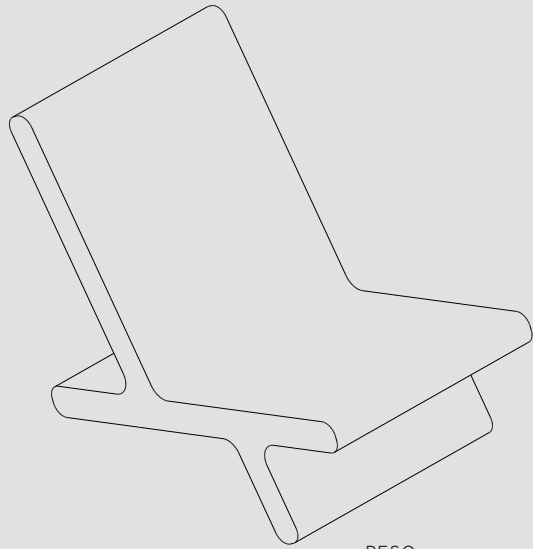

ONANZZA
70 cm x 55 cm x 92 cm

PESO
110 kg/und

PRECIO
1'825,280/Und
+IVA

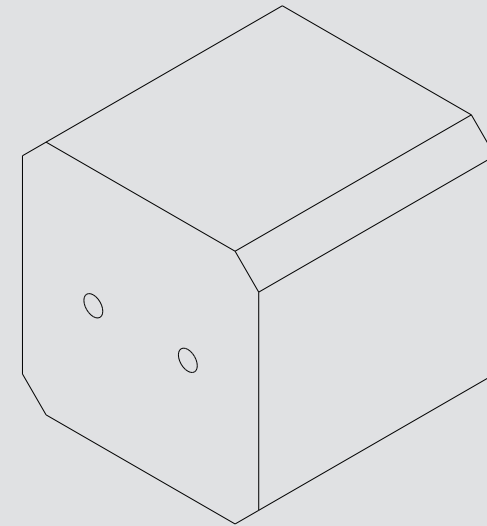

PONNA
50 cm x 50 cm x 50 cm

PESO
100 kg/und

PRECIO
---,---/Und
+IVA

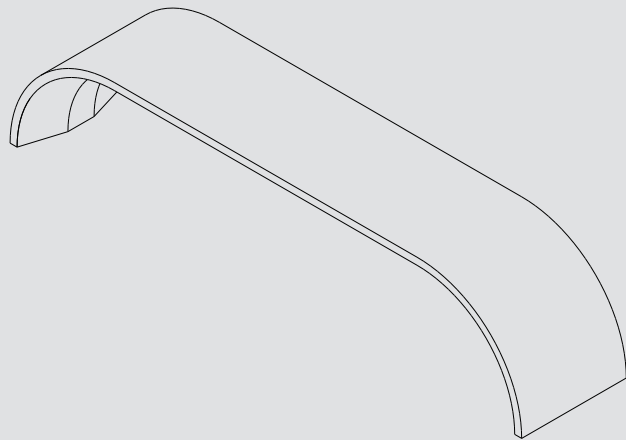

ASTTER
220 cm x 45 cm x 45 cm

PESO
180 kg/und

PRECIO
1'825,280/Und
+IVA

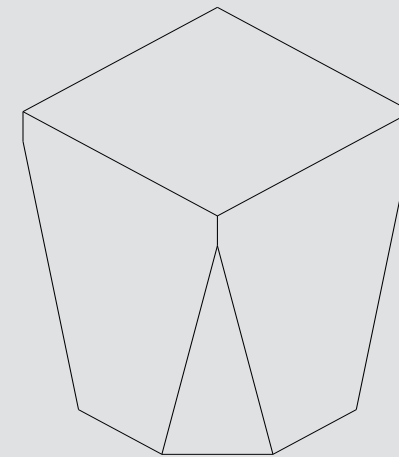

LIVVY
35 cm x 35 cm x 45 cm

PESO
50 kg/und

PRECIO
579,600/Und
+IVA

COLORES DISPONIBLES

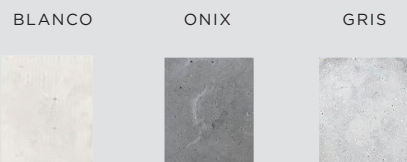

COLORES DISPONIBLES

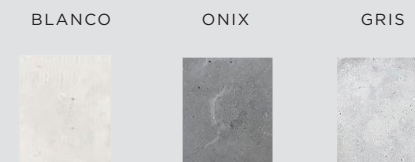



Los valores para los mobiliarios están antes de agregarles IVA.
Las tolerancias dimensionales son desde 3 mm en todas sus aristas.
La Tonalidad de los productos varia por la naturaleza del concreto.
Precios 2026 descarga el catalogo completo en www.innovacron.com.co

PRECIOS
MOBILIARIO

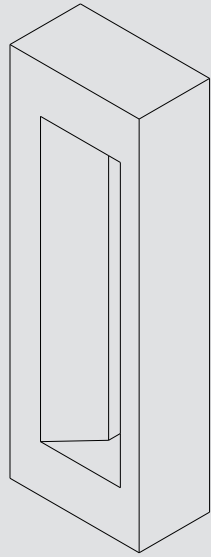

TRALISS
80 cm x 15 cm x 25 cm

PESO
50 kg/und

PRECIO
733,700/Und
+IVA

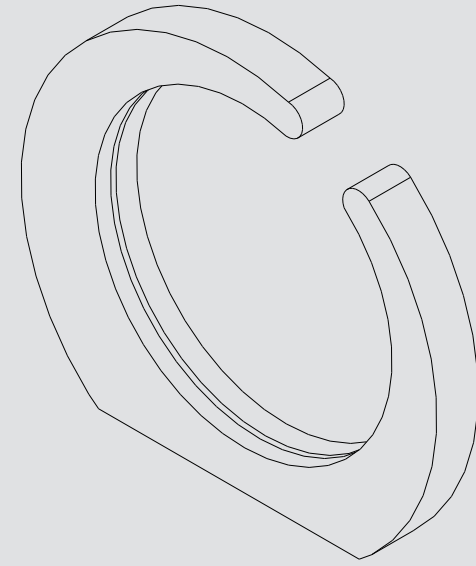

TERRESTRISS
78 cm x 69 cm x 8.5 cm

PESO
38 kg/und

PRECIO
733,700/Und
+IVA

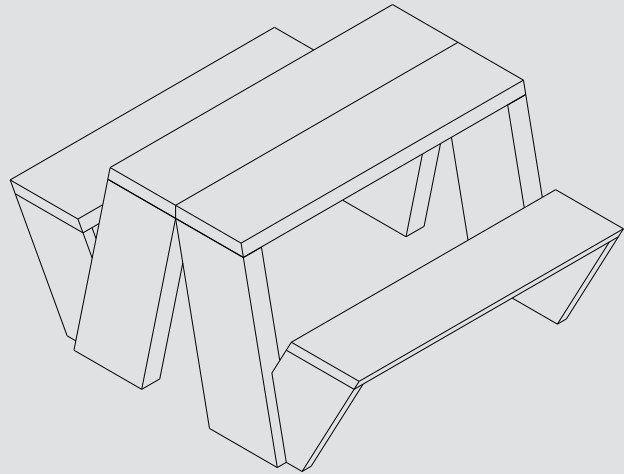

ELEGANZZ
120 cm x 60 cm x 75-45 cm

PESO
320 kg/und

PRECIO
2'504,700/Und
+IVA

COLORES DISPONIBLES

BLANCO

ONIX

GRIS

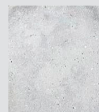
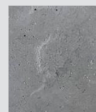
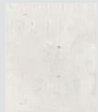

COLORES DISPONIBLES

BLANCO

ONIX

GRIS

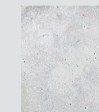
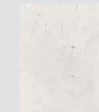

NOSOTROS

COLOMBIA

Medellin, Antioquia
Colombia

+57 321 800 9632
contacto@innovacron.co

CARIBE Y CENTRO AMÉRICA

Rep. Dominicana
Costa Rica
Panamá

+1 312 887 6845
Internacional@innovacro.co

SOCIAL

@Innovacron
Pinterest.com/Innovacron
www.innovacron.com.co

